



iB02-23-24

Plans / Scope of work

Early Learning Edenvale Classroom Refresh

Santa Clara County Of Education

5319 Carryback Ave, San Jose, CA 95111

Project Title:

**EARLY LEARNING EDENVALE
CLASSROOM REFRESH**

Drawing Title:

EDENVALE

**5319 Carryback Ave,
San Jose, CA 95111**

ISSUE DATES

REV	DESCRIPTION	DATE
	Bid Submittal	08.10.23

PROJECT CODE:

ISSUED:

SHEET NAME:

01



Project Title:
 EARLY LEARNING EDENVALE
 CLASSROOM REFRESH

Drawing Title:
 Classroom Location

5319 Carryback Ave,
 San Jose, CA 95111

ISSUE DATES		
REV	DESCRIPTION	DATE
	Bid Submittal	08.10.23

PROJECT CODE: _____
 ISSUED: _____
 SHEET NAME: _____

02

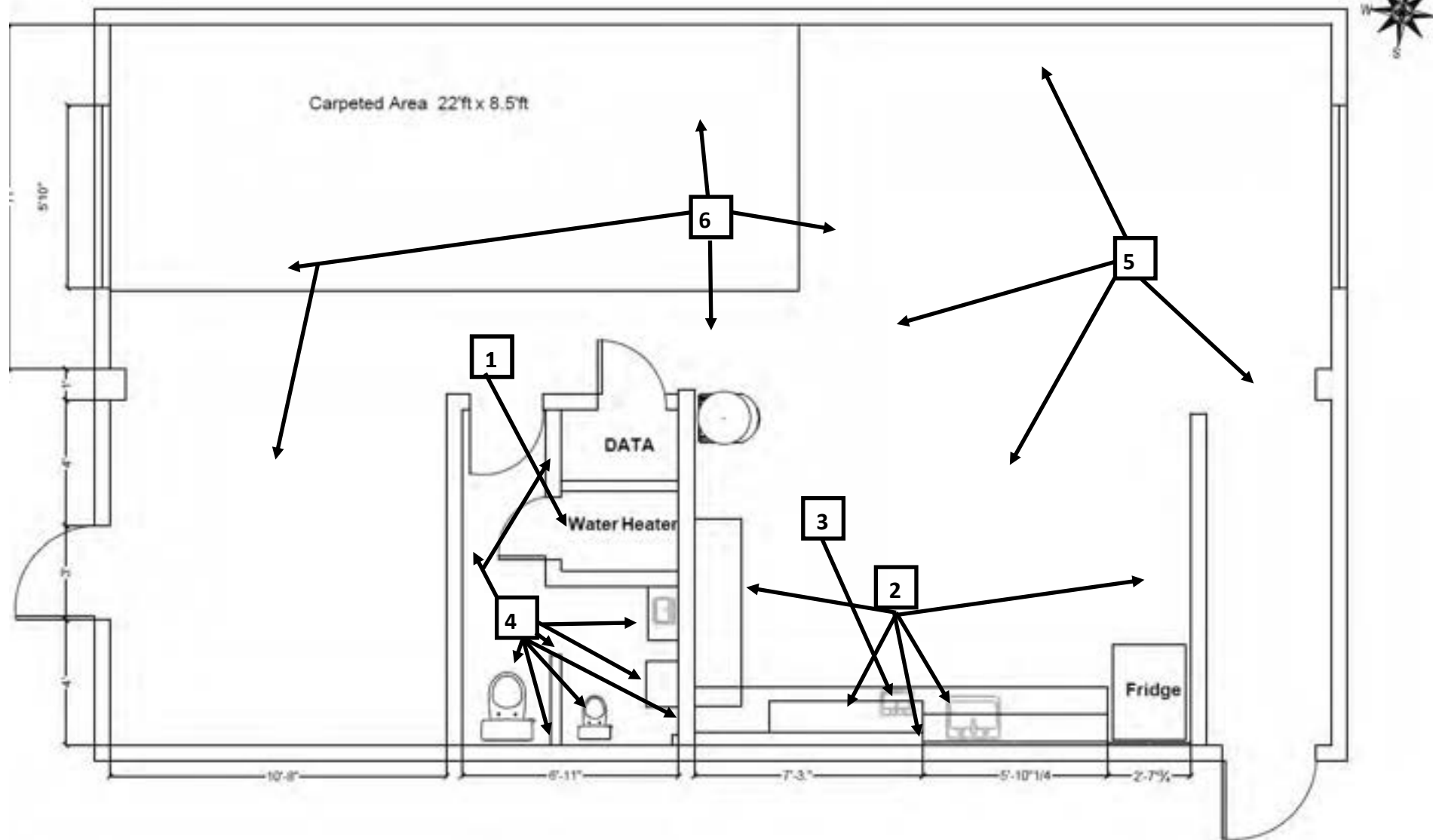

Project Title:
EARLY LEARNING EDENVALE
CLASSROOM REFRESH

Drawing Title:
Demo Phase

5319 Carryback Ave,
San Jose, CA 95111

ISSUE DATES

REV	DESCRIPTION	DATE
	Bid Submittal	08.10.23

PROJECT CODE: _____

ISSUED: _____

SHEET NAME: _____

Demo Phase

- 1. Water heater and Water Dispenser:**
 - Carefully disconnect and remove from its current location before the demolition begins.
 - Properly protect and securely store in a designated area to prevent damage or deterioration during the demolition process.
 - Ensure storage preserves its condition and functionality for future reinstallation.
- 2. Kitchen:**
 - Demo and dispose of all upper and lower cabinets.
 - Demo and dispose of all FRP Panels.
- 3. Kids Sink:**
 - Demo and dispose of the kids sink.
 - Cap and remove water and sewer lines associated with the sink.
- 4. Bathroom:**
 - Demo and dispose of upper and lower cabinets.
 - Demo and dispose of both toilets and wall partition.
 - Demo and dispose of FRP Panels.
- 5. Baseboards:**
 - Demo and dispose of all baseboards throughout the designated area.
- 6. Flooring:**
 - Demo and dispose of all flooring, underlayment, and any damaged subfloor.

Please ensure that all items are handled and disposed of in compliance with relevant regulations and best practices. CONTRACTOR SHALL PROTECT PORTIONS OF EXISTING CONSTRUCTION NOT INDICATED TO BE DEMOLISHED. CONTRACTOR SHALL BE RESPONSIBLE FOR THE REPLACEMENT & REPAIR OF ITEMS TO REMAIN.

Installation Phase:

1. Remove any nails, screws, staples ETC. Patch all walls from demo, texture to match room, prime, and paint to cover.
2. Install FRP on all walls in the kitchen and bathroom, referring to the provided drawing.
3. Level the classroom floor, patching as needed, and install underlayment and self-leveling compound, Patch any gaps as required and install flooring per the manufacturing requirements.
4. Prepare the area for two additional handwashing sinks, one for adults and one for kids, as indicated in the kitchen drawing. Also backing to be installed for wall mount sink and ensure proper support for wall mount or floor mount per manufacturer requirements.
5. Prepare plumbing in the designated area for a new dishwasher and sink.
6. Install upper and lower cabinets in the kitchen and bathroom.
7. Install 1 (one) adult hand washing station & 1 (one) kids hand washing station and attach plumbing accordingly to existing plumbing, Also install 1 (one) Soap Dispensers, and 1 (one) Paper Towel Dispensers. Soap Dispenser location will be between the two sinks and paper towel dispenser on the right of the adult sink.
8. Install 2 New kids' toilet and attach plumbing accordingly, toilet paper dispenser, and Grab Bar.
9. Install Partition wall between the two toilets.
10. Provide Power for Dishwasher & Garbage disposal(with switch at backsplash).
11. Install kitchen Sink, Garbage disposal, faucet, Dishwasher and attach plumbing accordingly, Also install Soap Dispenser, and Paper Towel Dispenser.
12. Install Bathroom Sink, faucet, Soap Dispenser, Mirror, Paper Towel Dispenser, and Backing for sink.
13. Remove do not paint around outlets, switches, cover plates, etc.
14. Install a Water ball valve shut off for the classroom with proper access cover/panel.
15. Label electrical breakers for Dishwasher and Garbage Disposal at the panel.

Note: Contractor shall protect portions of existing construction not indicated to be demolished. Contractor shall be responsible for the replacement & repair of items to remain.



Project Title:
EARLY LEARNING EDENVALE
CLASSROOM REFRESH

Drawing Title:
Installation Phase

5319 Carryback Ave,
San Jose, CA 95111

ISSUE DATES		
REV	DESCRIPTION	DATE
	Bid Submittal	08.10.23

PROJECT CODE: _____
ISSUED: _____
SHEET NAME: _____

Project Title:
EARLY LEARNING EDENVALE
CLASSROOM REFRESH

Drawing Title:
Installation Phase

5319 Carryback Ave,
San Jose, CA 95111

ISSUE DATES		
REV	DESCRIPTION	DATE
	Bid Submittal	08.10.23

PROJECT CODE: _____
ISSUED: _____
SHEET NAME: _____

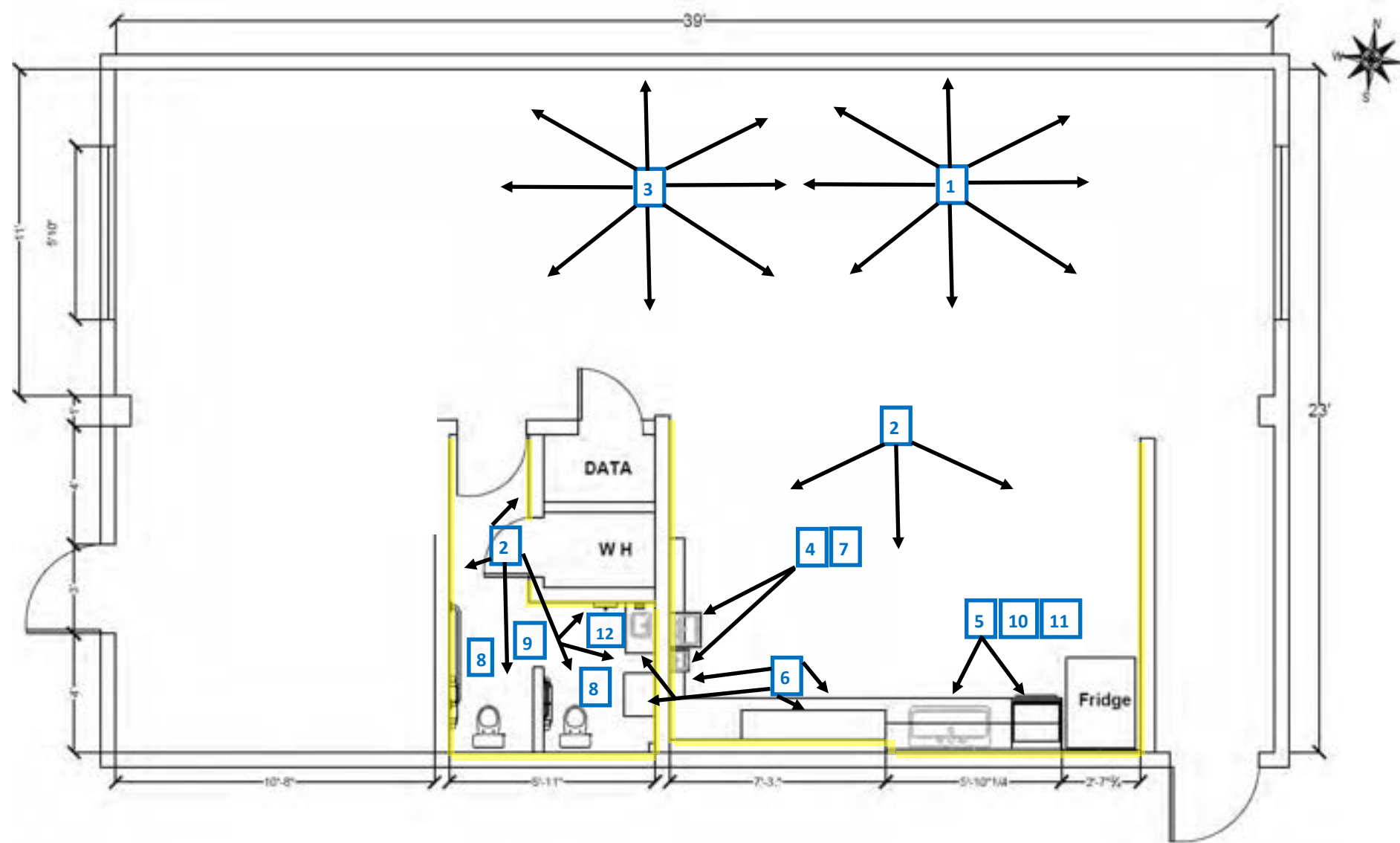

Project Title:
EARLY LEARNING EDENVALE
CLASSROOM REFRESH

Drawing Title:
Kitchen Installation
Zoomed In

5319 Carryback Ave,
San Jose, CA 95111

ISSUE DATES

REV	DESCRIPTION	DATE
	Bid Submittal	08.10.23

PROJECT CODE: _____

ISSUED: _____

SHEET NAME: _____

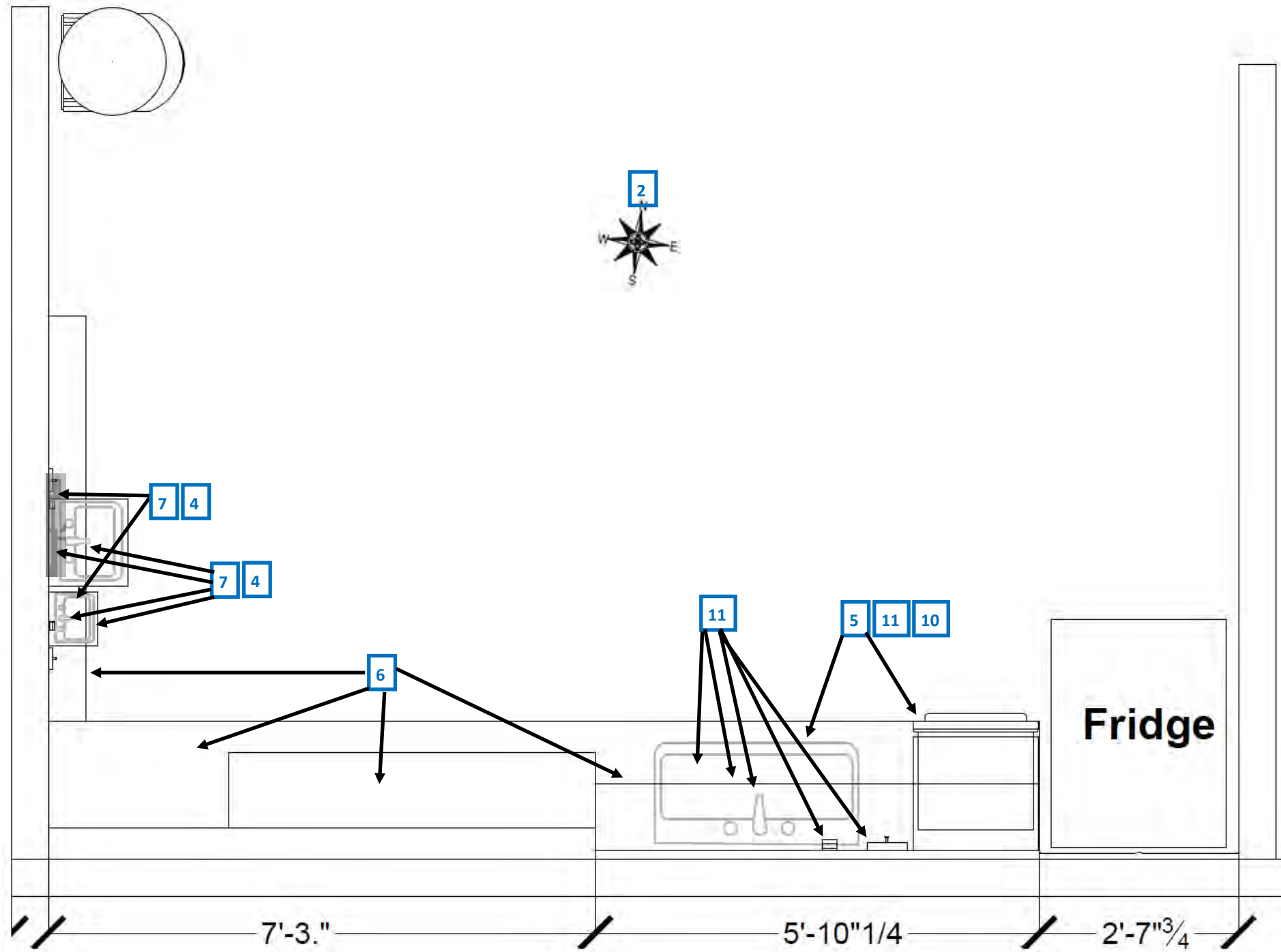

2 FRP height

West: exposed wall with sink

East: 4 ft wall

South: Back Splash only.



Model: K-2005-0



Model: K-2032-0

WEST

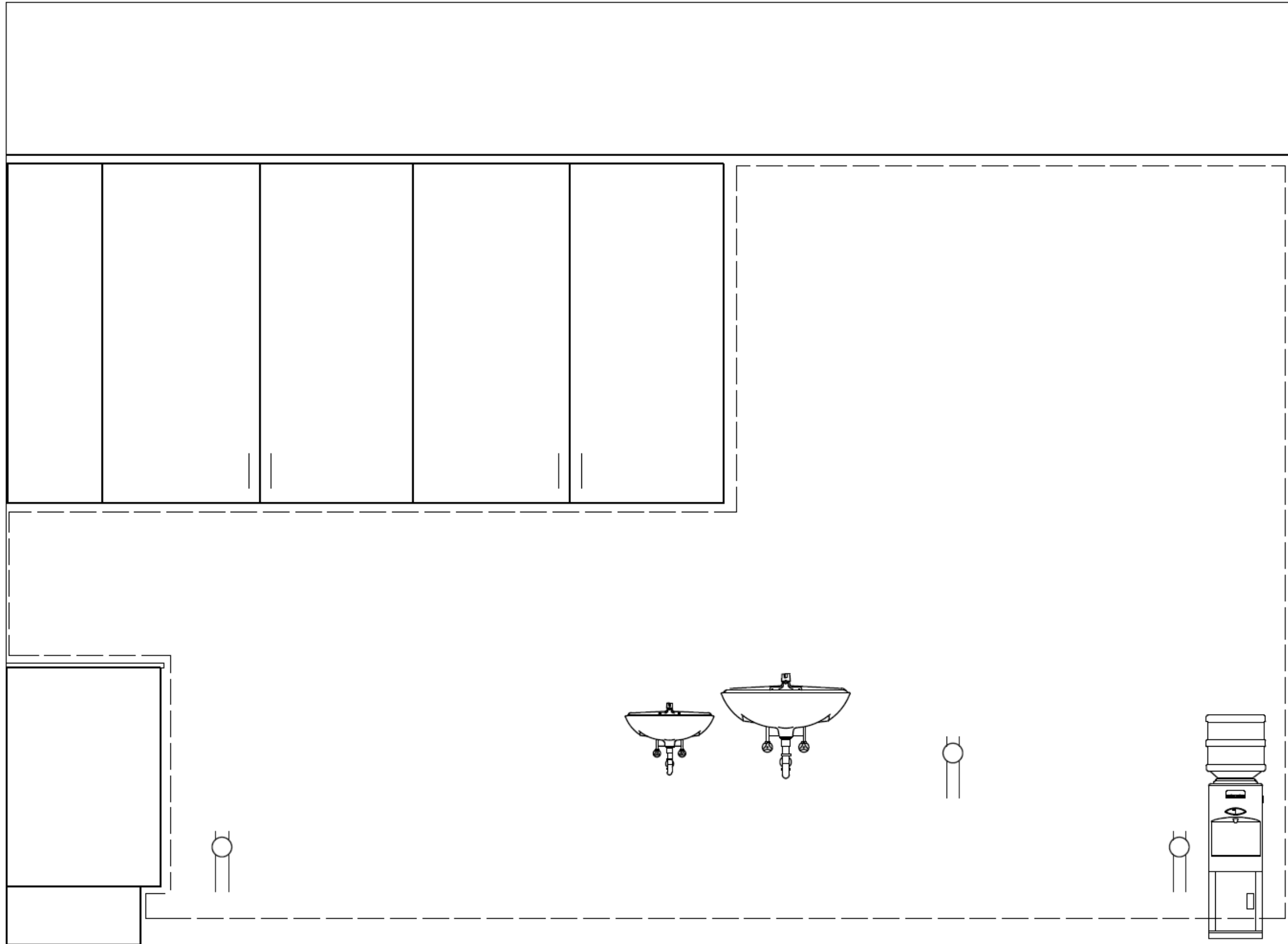

Project Title:
EARLY LEARNING EDENVALE
CLASSROOM REFRESH

Drawing Title:
Kitchen West Elevation

5319 Carryback Ave,
San Jose, CA 95111

ISSUE DATES		
REV	DESCRIPTION	DATE
	Bid Submittal	08.10.23

PROJECT CODE: _____
ISSUED: _____
SHEET NAME: _____

07

Project Title:
EARLY LEARNING EDENVALE
CLASSROOM REFRESH

Drawing Title:
Kitchen South Elevation

5319 Carryback Ave,
San Jose, CA 95111

ISSUE DATES

REV	DESCRIPTION	DATE
	Bid Submittal	08.10.23

PROJECT CODE: _____

ISSUED: _____

SHEET NAME: _____

South

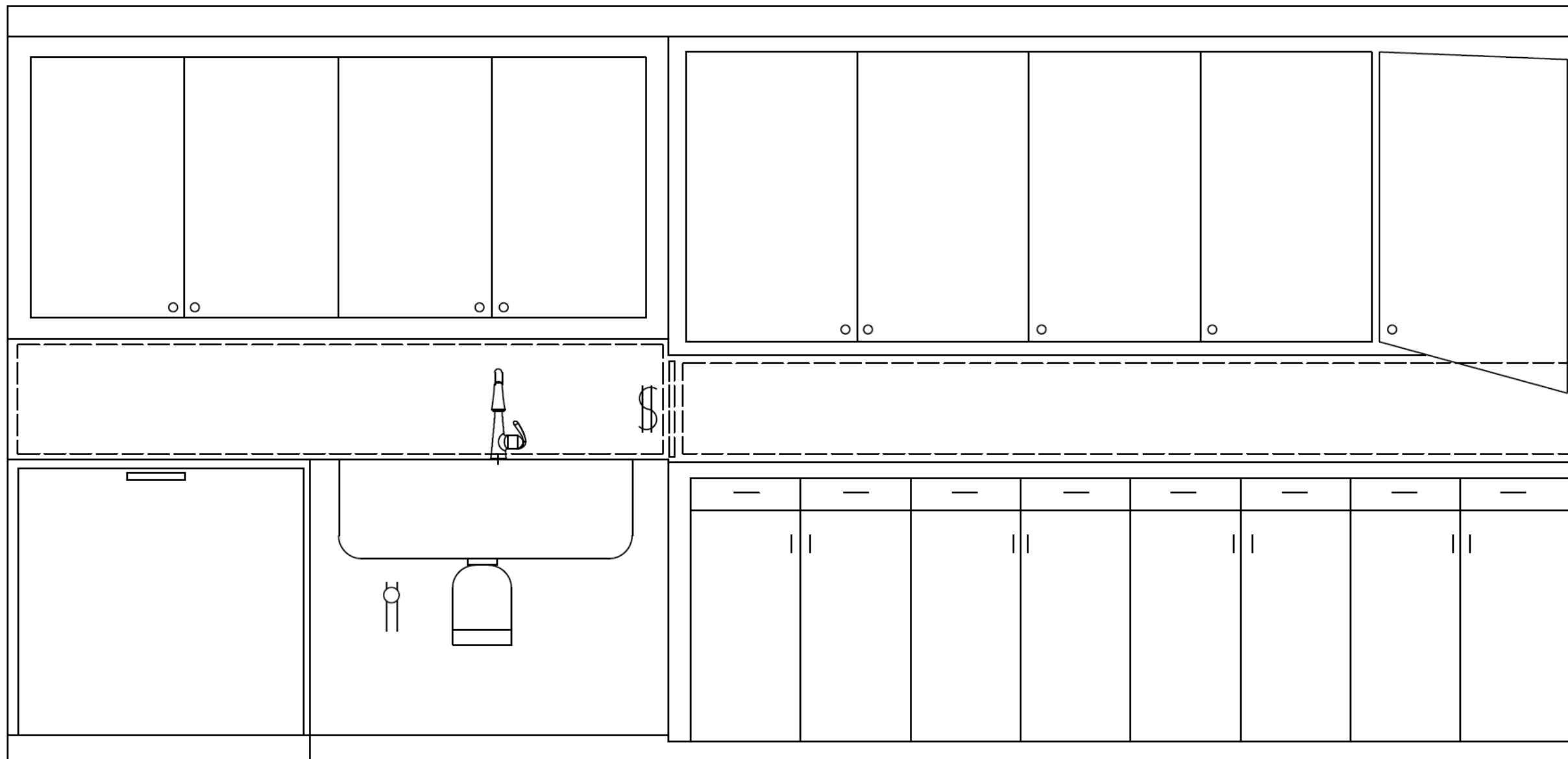

08



Project Title:
EARLY LEARNING EDENVALE
CLASSROOM REFRESH

Drawing Title:
Kitchen East Elevation

5319 Carryback Ave,
San Jose, CA 95111

ISSUE DATES

REV	DESCRIPTION	DATE
	Bid Submittal	08.10.23

PROJECT CODE: _____

ISSUED: _____

SHEET NAME: _____

EAST

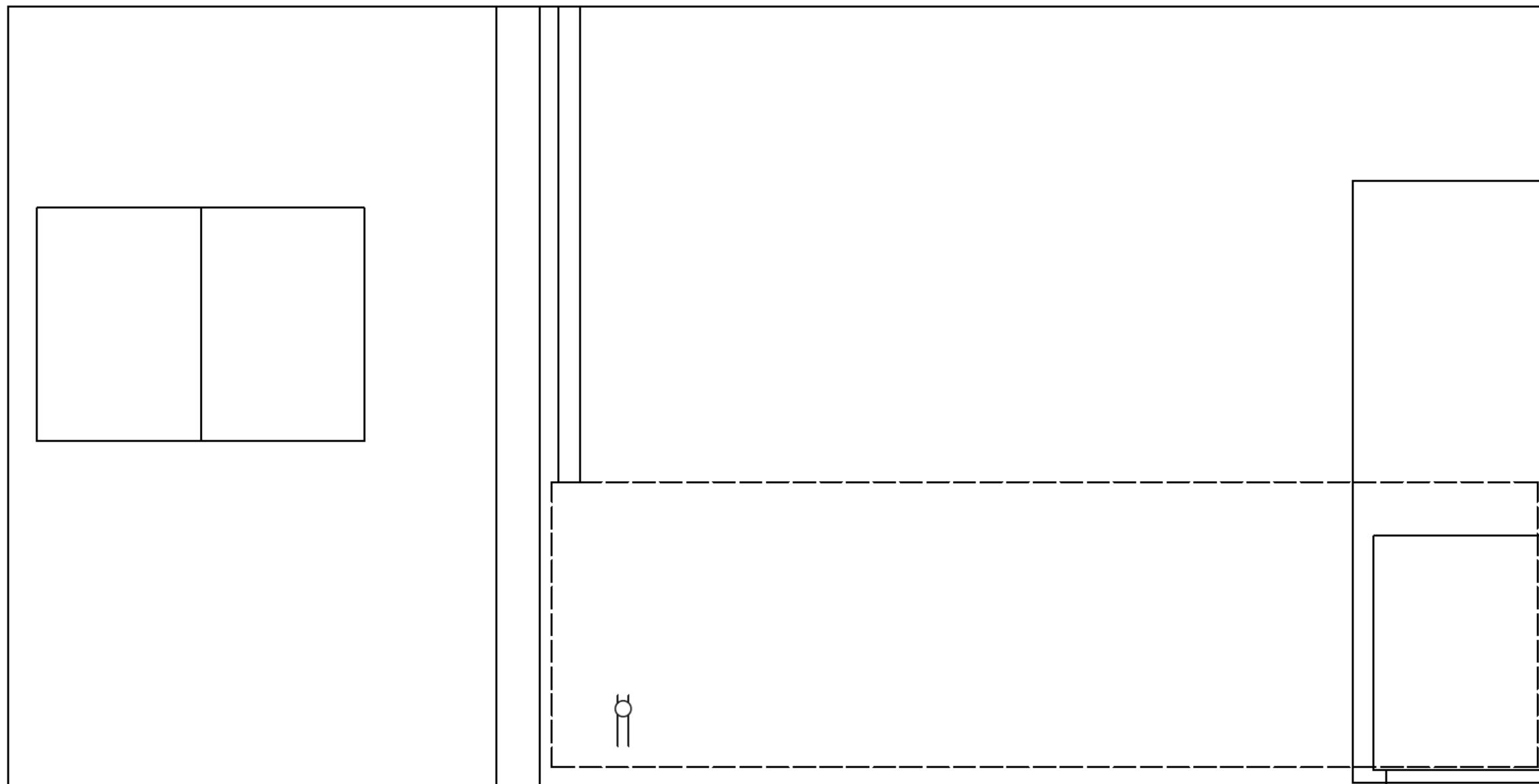

09

NOTE:
NO SHARP EDGES OR
ABRASIVE SURFACES
UNDER LAVATORY

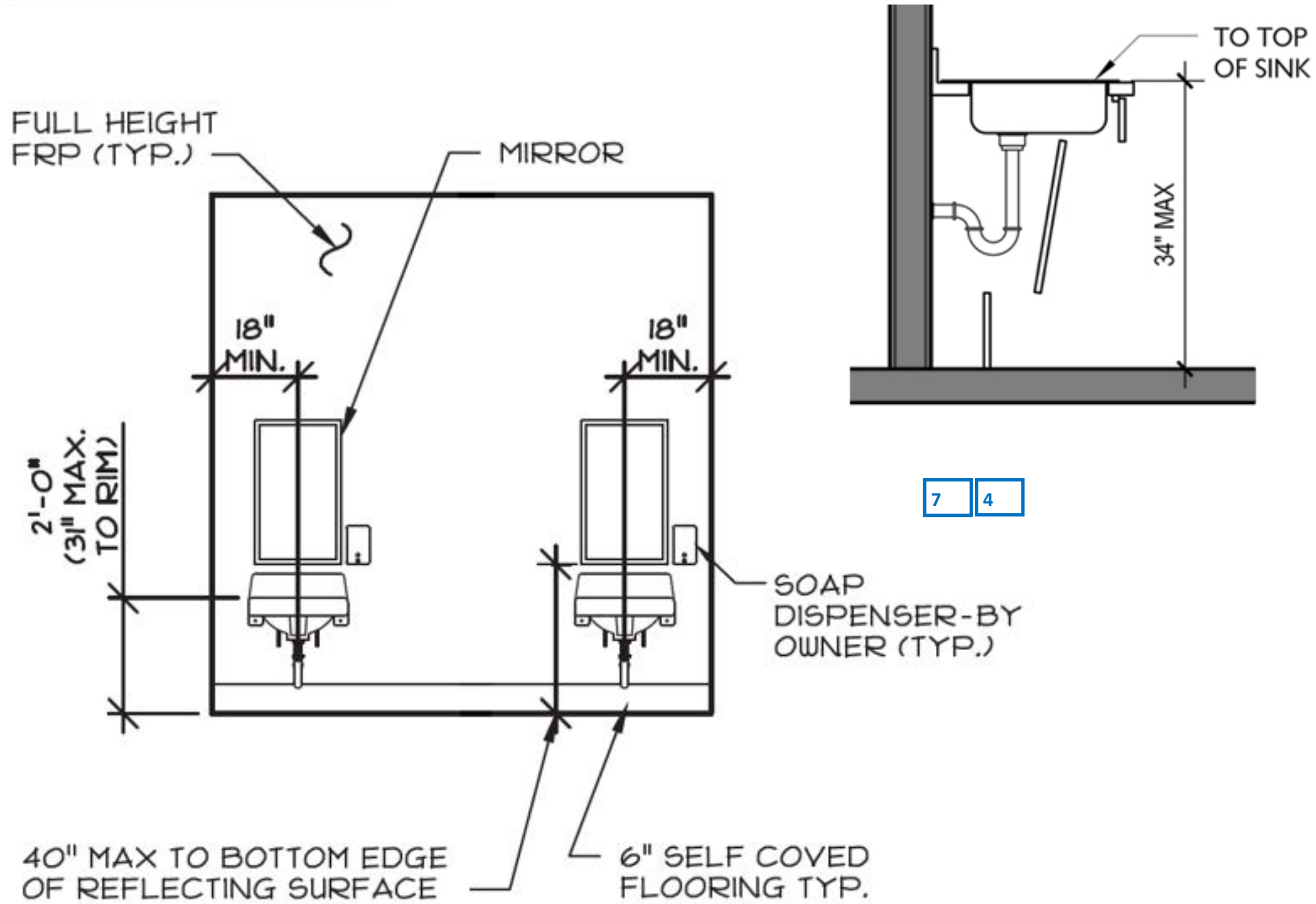

Concept Only

Project Title:
EARLY LEARNING EDENVALE
CLASSROOM REFRESH

Drawing Title:
Sink Layout

5319 Carryback Ave,
San Jose, CA 95111

ISSUE DATES		
REV	DESCRIPTION	DATE
	Bid Submittal	08.10.23

PROJECT CODE: _____
ISSUED: _____
SHEET NAME: _____

Project Title:
EARLY LEARNING EDENVALE
CLASSROOM REFRESH

Drawing Title:
Casework Concept

5319 Carryback Ave,
San Jose, CA 95111

ISSUE DATES		
REV	DESCRIPTION	DATE
	Bid Submittal	08.10.23

PROJECT CODE: _____

ISSUED: _____

SHEET NAME: _____

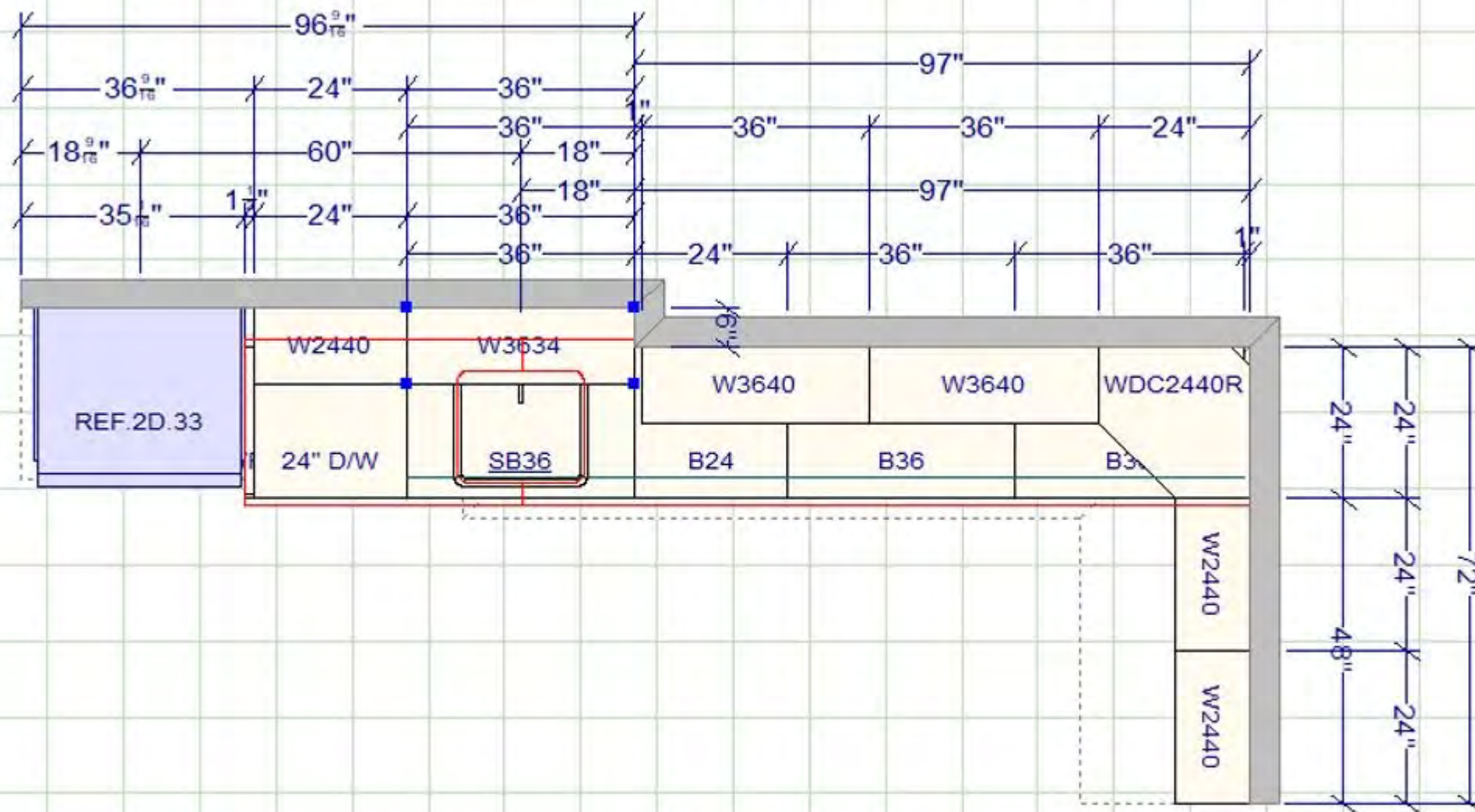

Concept By KZ



Concept By KZ

Project Title:
EARLY LEARNING EDENVALE
CLASSROOM REFRESH

Drawing Title:
Casework Finish

5319 Carryback Ave,
San Jose, CA 95111

ISSUE DATES		
REV	DESCRIPTION	DATE
	Bid Submittal	08.10.23

PROJECT CODE: _____
ISSUED: _____
SHEET NAME: _____

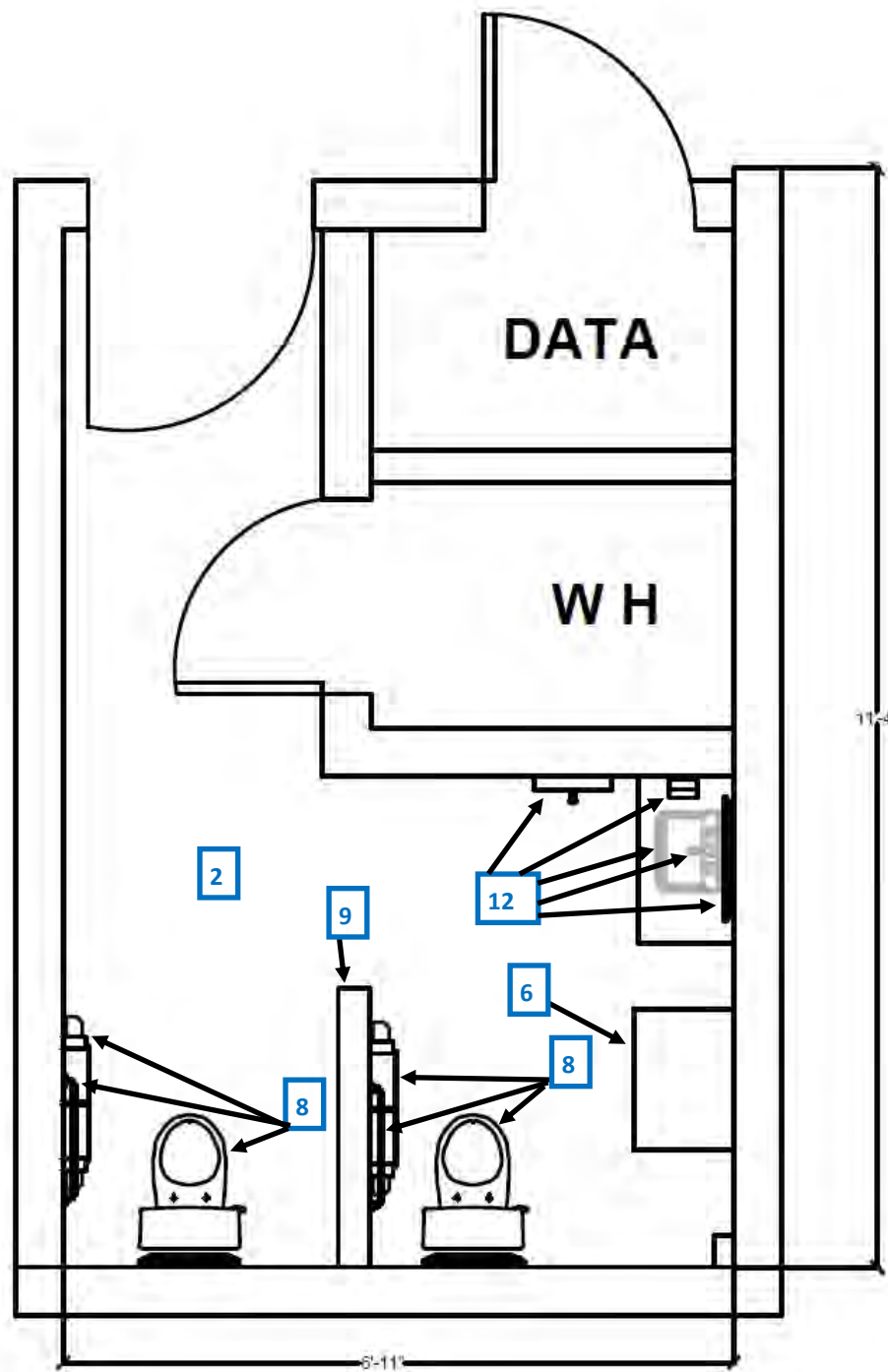

FRP height:
FRP all walls full Height.

Project Title:
EARLY LEARNING EDENVALE
CLASSROOM REFRESH

Drawing Title:
Bathroom Installation
Zoomed In

5319 Carryback Ave,
San Jose, CA 95111

ISSUE DATES

REV	DESCRIPTION	DATE
	Bid Submittal	08.10.23

PROJECT CODE: _____
 ISSUED: _____
 SHEET NAME: _____

Edenvale Classroom finish Schedule

FLOORS

Menards.com Forbo Allura Flex Color: Pure Oak

BASEBOARD

Commercial Rubber Base MFG TBD Color: TBD Size: 6"

WALLS

Panolam FRP Panels The Classic Collection White Smooth Surface Full height of all the walls with trim

Patch prime and Paint to cover Swisse coffee semi-gloss Match existing Texture

CABINETS

KZ kitchen Cabinets & Stone In. MILKYWAY - CREAMY WHITE SHAKER DOOR STYLE plywood



Project Title:
EARLY LEARNING EDENVALE
CLASSROOM REFRESH

Drawing Title:
Finish & Fixture Schedule

5319 Carryback Ave,
San Jose, CA 95111

ISSUE DATES		
REV	DESCRIPTION	DATE
	Bid Submittal	08.10.23

PROJECT CODE: _____
 ISSUED: _____
 SHEET NAME: _____

Items	Mark	MFG	Model	Color	Description
Partition	PT-1	Bobrick	1092	TBD	Wall mounted Dimensions (depth: 23.5", Height: Maximum 40", off the ground: 6"
Water Closet	WC-1	American Standard	Baby Devoro FloWise 2315.228.020	White	American Standard Baby Devoro FloWise 10 Inch High Round Front Toilet - 1.28 gpf, White - 2315.228.020 Contractor To Install
Toilet Tissue Dispenser	TTD-1	Universal	18838	SMOKE	Supplied By Owner Contractor To Install Dubl-Serv Side By Side Toilet Roll Dispenser
Lavatory	L-1	Kohler	K-2032-0	White	Adult. Kohler Greenwich 20-3/4" Wall Mounted Bathroom Sink with 3 Holes Drilled and Overflow
Lavatory	L-2	Kohler	K-2005-0	White	Kids. Kohler Kingston 16" Wall Mounted Bathroom Sink with 3 Holes Drilled and Overflow
Faucet	F-1	Pfister	LF-042-LRGS	Brushed Nickel	Ladera Single-Hole Single-Handle Bathroom Faucet in Spot Defense Brushed Nickel Internet #300721639 Model #LF-042-LRGS Store SKU #1002255419
Kitchen Sink	KS-1	Glacier Bay	Model # VT2522TA1ACC-2A Store SKU # 1007918043	Stainless Steel	Bratten Drop-In/Undermount 18G Stainless Steel 25 in. 2-Hole Single Bowl Kitchen Sink with Accessories. Brushed 20-Gauge Stainless Steel 30 in. Single Bowl Undermount Scratch-Resistant Nano Kitchen Sink with Strainer. Contractor To Install
Dishwasher	D-1	Bosch	GDT635HSMSS	Stainless Steel	Supplied By Owner Contractor To Install Bosch 800 Series 24 in. ADA Front Control Dishwasher in Stainless Steel with Stainless Steel Tub and 3rd Rack, 44dBA-SGE68X55UC
Garbage Disposal	GD-1	EVERBILT	Model # 10-US- EB500M-BL	Black	Designer Series 1/2 HP Continuous Feed Garbage Disposal with Black Sink Flange and Attached Power Cord Internet #308822144 Model #10-US-EB500M-BL Store SKU
CABINETS	UPCA-1	Contractor to provide	TBD	Plywood brown	Contractor To Install TBD
CABINETS	CA-1	Contractor to provide	TBD	Plywood brown	Contractor To Install TBD
Soap Dispenser	S-1	Gojo	800 Series	Black	Supplied By Owner Contractor To Install GOJO® SURFACE MOUNT SOAP DISPENSERS
Towel Dispenser	T-1	San Jamar	T8400	Black	Supplied By Owner Contractor To Install San Jamar T8400TBK Smart Essence Classic Hands Free Paper Towel Dispenser - Black

Items	Mark	MFG	Model	Color	Description
Mirror	M-1	Bobrick	B2921836	Stainless	Bobrick B-292 1836 Angle Frame Mirror with Shelf 18" x 36" Contractor To Install
ADA Grab Bars	GB-1	Bobrick	B-5806 x 24	Stainless	Horizontal Grab Bar Contractor To Install
ADA Grab Bars	GB-2	Bobrick	B-5806 x 36	Stainless Steel	Horizontal Grab Bar Contractor To Install
Kitchen Faucet	F-2	MOEN	87233SRS	Stainless Steel	Adler Single-Handle Pull-Down Sprayer Kitchen Faucet with Power Clean and Reflex in Spot Resist Stainless



Project Title:
**EARLY LEARNING EDENVALE
CLASSROOM REFRESH**

Drawing Title:
Fixture Schedule

**5319 Carryback Ave,
San Jose, CA 95111**

ISSUE DATES		
REV	DESCRIPTION	DATE
	Bid Submittal	08.10.23

PROJECT CODE: _____
ISSUED: _____
SHEET NAME: _____

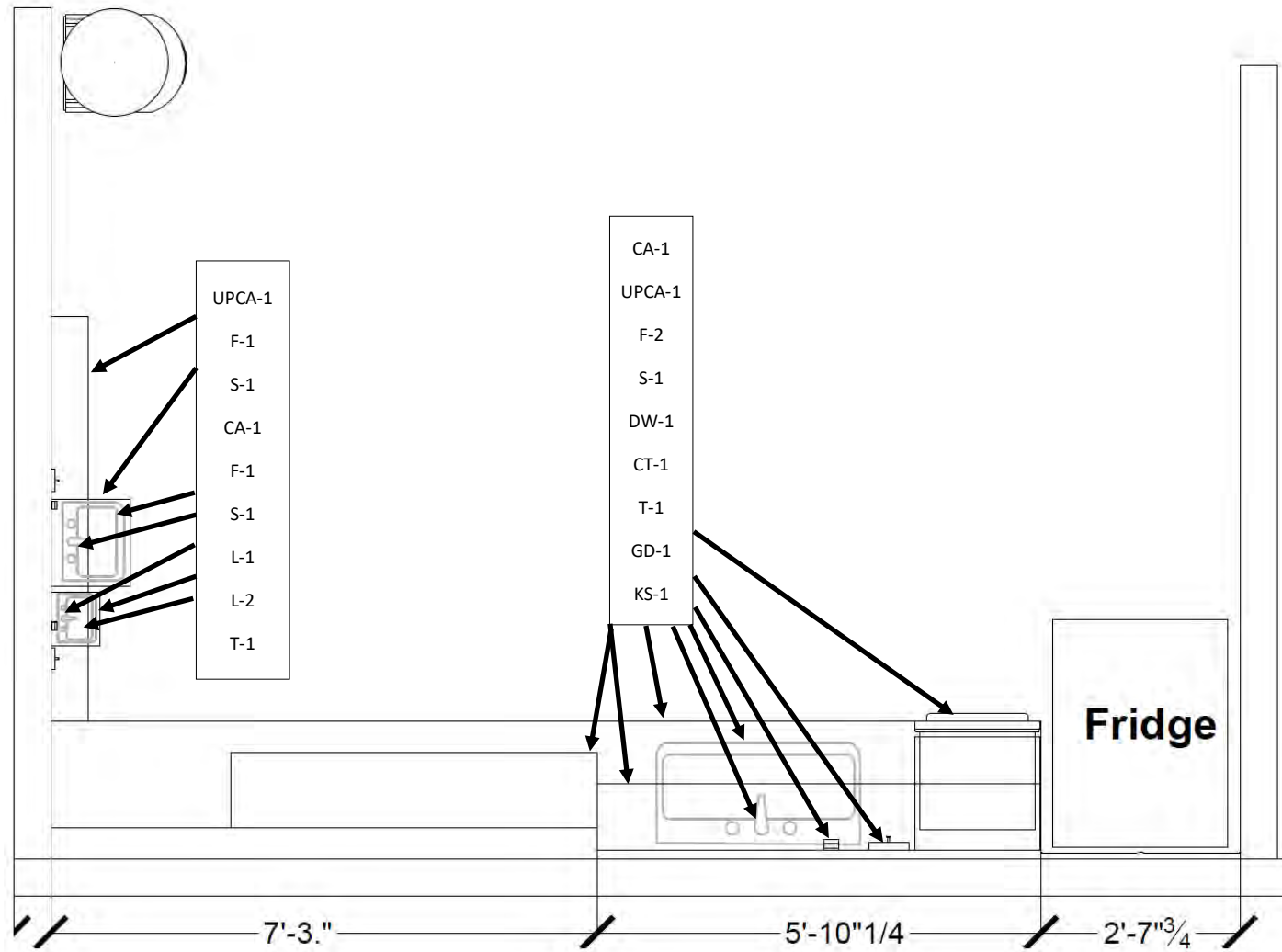

Project Title:
EARLY LEARNING EDENVALE
CLASSROOM REFRESH

Drawing Title:
Kitchen Installation
Zoomed In

5319 Carryback Ave,
San Jose, CA 95111

ISSUE DATES		
REV	DESCRIPTION	DATE
	Bid Submittal	08.10.23

PROJECT CODE: _____
ISSUED: _____
SHEET NAME: _____

Project Title:
EARLY LEARNING EDENVALE
CLASSROOM REFRESH

Drawing Title:
Bathroom Installation
Zoomed in

5319 Carryback Ave,
San Jose, CA 95111

ISSUE DATES

REV	DESCRIPTION	DATE
	Bid Submittal	08.10.23

PROJECT CODE:

ISSUED:

SHEET NAME:

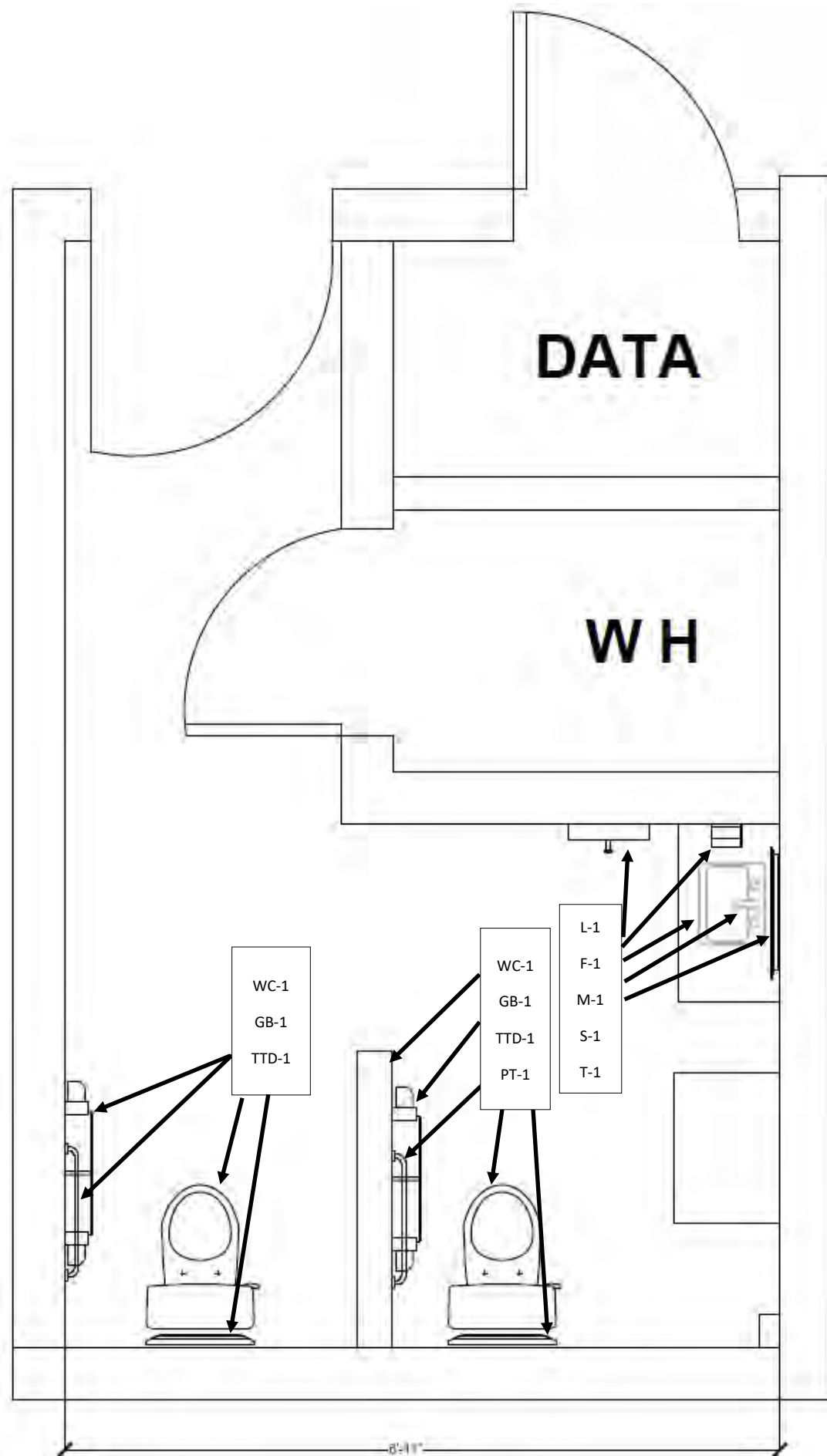



Project Title:
EARLY LEARNING EDENVALE
CLASSROOM REFRESH

Drawing Title:
exterior existing Images

5319 Carryback Ave,
San Jose, CA 95111

ISSUE DATES		
REV	DESCRIPTION	DATE
	Bid Submittal	08.10.23

PROJECT CODE: _____

ISSUED: _____

SHEET NAME: _____

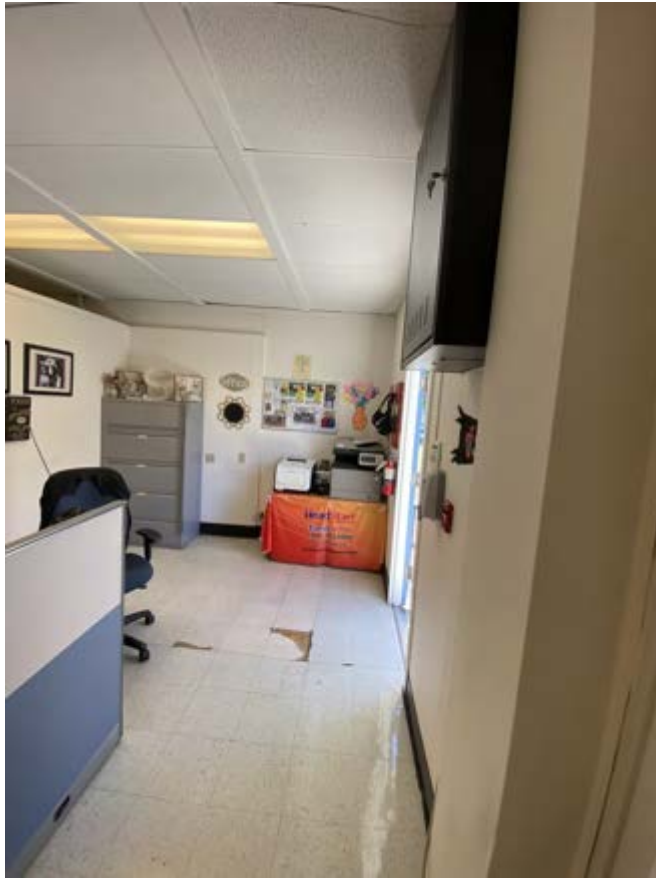

Project Title:
EARLY LEARNING EDENVALE
CLASSROOM REFRESH

Drawing Title:
Interior existing Images

5319 Carryback Ave,
San Jose, CA 95111

ISSUE DATES		
REV	DESCRIPTION	DATE
	Bid Submittal	08.10.23

PROJECT CODE: _____

ISSUED: _____

SHEET NAME: _____



Project Title:
EARLY LEARNING EDENVALE
CLASSROOM REFRESH

Drawing Title:
Interior existing Images

5319 Carryback Ave,
San Jose, CA 95111

ISSUE DATES		
REV	DESCRIPTION	DATE
	Bid Submittal	08.10.23

PROJECT CODE: _____
ISSUED: _____
SHEET NAME: _____



Project Title:
EARLY LEARNING EDENVALE
CLASSROOM REFRESH

Drawing Title:
Interior existing Images

5319 Carryback Ave,
San Jose, CA 95111

ISSUE DATES		
REV	DESCRIPTION	DATE
	Bid Submittal	08.10.23

PROJECT CODE: _____
 ISSUED: _____
 SHEET NAME: _____



Project Title:
EARLY LEARNING EDENVALE
CLASSROOM REFRESH

Drawing Title:
Interior existing Images

5319 Carryback Ave,
San Jose, CA 95111

ISSUE DATES		
REV	DESCRIPTION	DATE
	Bid Submittal	08.10.23

PROJECT CODE: _____

ISSUED: _____

SHEET NAME: _____